



MR150

INDUSTRIAL RANGE



GENERATING SETS

WATER COOLED THREE PHASES 50 HZ DIESEL

Service		Standby	Prime
Power	kVA	150	135
Power	kW	121	110
Rated Speed	r.p.m	1500	
Standart Voltage	V	400/230	
Rated At Power Factor	Cos Phi	0,8	

MAR-KIM Company with quality certification ISO 9001

MAR-KIM gensets are compliant with EC mark which includes the following directives:

- 2006/42/CE Machinery safety.
- 2014/30/UE Electromagnetic compatibility.
- 2014/35/UE electrical equipment designed for use within certain voltage limits
- 2000/14/EC Sound Power level. Noise emissions outdoor equipment. (amended by 2005/88/EC)
- 97/68/EC Emissions of gaseous and particulate pollutants. (amended by 2002/88/EC & 2004/26/EC)
- EN 12100, EN 13857, EN 60204

Ambient conditions of reference according to ISO 8528-1:2005 normative: 1000 mbar, 25°C, 30% relative humidity.

G2 class load acceptance in accordance with ISO 8528-5:2013

MAR-KIM CHEMICALS CO.LTD.

KINONDONI TUNISIA ROAD. PLOT NO:137 DAR ES SALAM-TANZANIA

TEL : +2550786323584 | +255 0677 063 022 | +255 0677062024

akifkara46@gmail.com | www.markimgroup.co.tz | instagram: @markimperkinsgenerators



MR150

INDUSTRIAL RANGE



SPECIFICATIONS



Engine



Alternator

Engine		Specifications
Rated Output	<i>kW</i>	110
Manufacturer		Ricardo
Model		R6105AZLD
Engine Type		4 Stroke - Diesel
Injection Type		Direct Injection
Aspiration Type		Turbo Charge
Number of cylinder		6
Bore and Stroke	<i>mm</i>	105X130
Displacement	<i>L</i>	6,75
Cooling System		Water Cooling
Heating Power	<i>Watt</i>	1000W
Fuel Consumption 50% PRP	<i>l/h</i>	13,33
Fuel Consumption 75% PRP	<i>l/h</i>	15,38
Fuel Consumption 100 % PRP	<i>l/h</i>	20,51
Fuel Consumption Standby	<i>l/h</i>	
Lube oil consumption with full load	<i>[% fuel]</i>	1
Total oil capacity including tubes, filters	<i>L</i>	18
Total coolant capacity	<i>L</i>	25
Governor	<i>Type</i>	Mechanical or Electronic
Battery Capacity	<i>A</i>	2X60

Alternator		Specifications
Manufacturer		Maranello
Model		M150
Output Voltage	<i>V</i>	230/400
Frequency	<i>HZ</i>	50
Automatic Voltage Regulation	<i>±%</i>	1
Alternator Stand By Power	<i>kVA</i>	152
Alternator Continuous Power	<i>kVA</i>	140
Power Factor	<i>Cosφ</i>	0,8
Number of Wires		12
Winding		2/3
Protection Class		IP23 / H
Excitation System		Self-excited
AVR Model		SX460
Performance - PF 0,8 / %75 Load	<i>%</i>	94,1

Prime Power (PRP):

According to ISO 8528-1:2005, Prime power is the maximum power which a generating set is capable of delivering continuously whilst supplying a variable electrical load when operated for an unlimited number of hours per year under the agreed operating conditions with the maintenance intervals and procedures being carried out as prescribed by the manufacturer. The permissible average power output (P_{pp}) over 24 h of operation shall not exceed 70 % of the PRP.

Emergency Standby Power (ESP):

According to ISO 8528-1:2005, Emergency standby power is the maximum power available during a variable electrical power sequence, under the stated operating conditions, for which a generating set is capable of delivering in the event of a utility power outage or under test conditions for up to 200 h of operation per year with the maintenance intervals and procedures being carried out as prescribed by the manufacturers. The permissible average power output over 24 h of operation shall not exceed 70 % of the ESP.

Note: All data based on operation to ISO 3046/1, BS 5514 and DIN 6271 standard reference conditions



MR150

INDUSTRIAL RANGE



DIMENSIONS

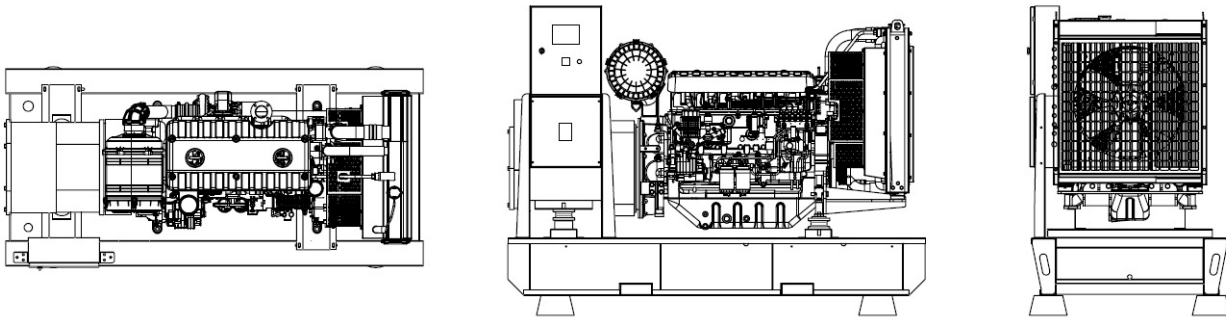

OPEN SET

LxWxH	mm	2200X1100X1700
Weight	kg	1450
Fuel Tank	lt	300

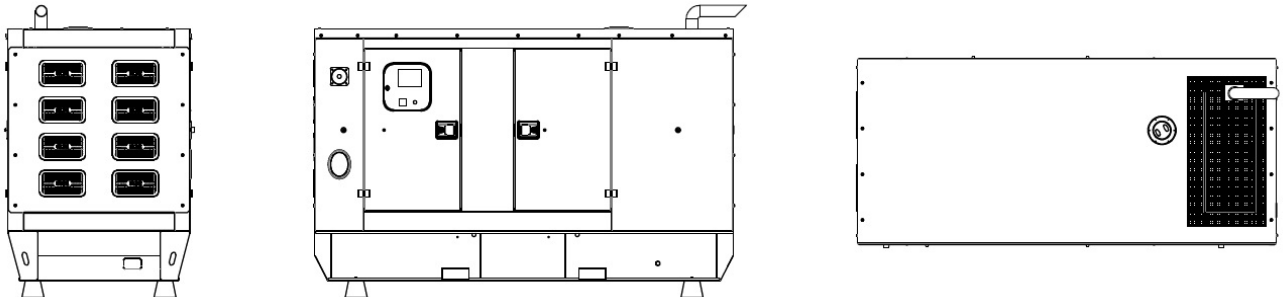

CANOPIED

LxWxH	mm	3200X1100X2100
Weight	kg	1780
Fuel Tank	lt	330

Sound Proof Canopy

- Special design for minimizing acoustic level.
- Galvanized steel construction further protected by polyester powder coat paint.
- Black finish stainless steel locks and hinges.
- Control panel viewing window in a lockable access door.
- Emergency stop push button (red) mounted on enclosure exterior.
- Lifting, drag and jacking points on base frame.
- Radiator fill via removable, flush mounted rain cap fitted with compression seal.
- Acoustic insulation with moisture-repellent and non-flammable material

MAR-KIM CHEMICALS CO.LTD.

KINONDONI TUNISIA ROAD. PLOT NO:137 DAR ES SALAM-TANZANIA

TEL : +2550786323584 | +255 0677 063 022 | +255 0677062024

akifkara46@gmail.com | www.markimgroup.co.tz | instagram: @markimperkinsgenerators



MR150

INDUSTRIAL RANGE



CONTROL UNIT



Control Unit

D500 - DATAKOM

4-band GPRS modem (optional)	Internet Central Monitoring
USB Device	SMS message sending
RS-232 (2400-57600baud)	E-mail sending
J1939-CANBUS	Free PC software: Rainbow Plus
Geo-locating through GSM	Modbus RTU
GPS support (RS-232)	

ATS PANEL

MAR-KIM automatic transfer switches are reliable, rugged, versatile, and compact assemblies for transferring essential loads and electrical distribution systems from one power source to another. MAR-KIM's contactor-based transfer switch is rated 40–3600A and can be supplied in separate enclosures for standalone applications or can be supplied as an integral component. Contactors inside the ATS panels are well known and internationally recognized brands such as ABB, SCHNEIDER, HYUNDAI and ANDELI.



OPTIONAL EQUIPMENTS

Some Optional Equipments that MAR-KIM provides with Generator Sets;

- Medium voltage alternator,
- Remote radiator applications,
- Automatic fuel filling system,
- Fuel tank, oil pan, dashboard, alternator, coil heaters,
- Alternator with double AVR and PMG,
- Synchronization systems, The generator output breaker,
- Grid-generator transfer switches,
- Accordance with the specific volume of demand-insulated cabins,
- Seismic solutions,
- Trailer,
- Remote monitoring.
- SMPS 12/24V 10A

Control Panel

- Datakom D500
- Datakom D700
- ComAp AMF9
- ComAp AMF25

MAR-KIM CHEMICALS CO.LTD.

KINONDONI TUNISIA ROAD. PLOT NO:137 DAR ES SALAM-TANZANIA

TEL : +2550786323584 | +255 0677 063 022 | +255 0677062024

akifkara46@gmail.com | www.markimgroup.co.tz | instagram: @markimperkinsgenerators